

TB 9-5120-212-24

CHANGE 1

DEPARTMENT OF THE ARMY TECHNICAL BULLETIN

CALIBRATION PROCEDURE FOR TORQUE WRENCHES, POWER-DYNE, MODELS PD 1220, PD 1220B, PD 1201, AND PD 2501; CONSOLIDATED DEVICES, MODELS DPT-1200, DPT-1200R, DPT-2500, AND DPT-2500R; TORQUE APPLICATOR, POWERDYNE, MODEL PD12003 AND ADVANCED TORQUE, MODEL CTW 1200-T55

Headquarters, Department of the Army, Washington, DC
29 April 2008

Distribution Statement A: Approved for public release; distribution is unlimited.

TB 9-5120-212-24, 28 December 2007, is changed as follows:

1. Remove old pages and insert new pages as indicated below. New or changed material is indicated by a vertical bar in the margin of the page.

Remove Pages

3 and 4
13 and 14

Insert Pages

3 and 4
13 and 14

2. File this change sheet in front of the publication for reference purposes.

By Order of the Secretary of the Army:

Official



JOYCE E. MORROW

*Administrative Assistant to the
Secretary of the Army*

0806006

GEORGE W. CASEY, JR.
*General, United States Army
Chief of Staff*

Distribution:

To be distributed in accordance with IDN 343740, requirements for calibration procedure
TB 9-5120-212-24.

*TB 9-5120-212-24

DEPARTMENT OF THE ARMY TECHNICAL BULLETIN

CALIBRATION PROCEDURE FOR TORQUE WRENCHES, POWER-DYNE, MODELS PD 1220, PD 1220B, PD 1201, AND PD 2501; CONSOLIDATED DEVICES, MODELS DPT-1200, DPT-1200R, DPT-2500, AND DPT-2500R; TORQUE APPLICATOR, POWERDYNE, MODEL PD12003 AND ADVANCED TORQUE, MODEL CTW 1200-T55

Headquarters, Department of the Army, Washington, DC
28 December 2007

Distribution Statement A: Approved for public release, distribution is unlimited.

REPORTING OF ERRORS AND RECOMMENDING IMPROVEMENTS

You can improve this manual. If you find any mistakes or if you know of a way to improve these procedures, please let us know. Mail your letter or DA Form 2028 (Recommended Changes to Publications and Blank Forms) directly to: Commander, U.S. Army Aviation and Missile Command, ATTN: AMSAM-MMC-MA-NP, Redstone Arsenal, AL 35898-5000. A reply will be furnished to you. You may also send in your comments electronically to our E-mail address: 2028@redstone.army.mil or by fax 256-842-6546/DSN 788-6546. For the World Wide Web use: <https://amcom2028.redstone.army.mil>. Instructions for sending an electronic 2028 can be found at the back of this manual.

SECTION		Paragraph	Page
I.	IDENTIFICATION AND DESCRIPTION		
	Test instrument identification	1	2
	Forms, records, and reports.....	2	2
	Calibration description	3	2
II.	EQUIPMENT REQUIREMENTS		
	Equipment required.....	4	3
	Accessories required.....	5	3
III.	CALIBRATION PROCESS FOR MODELS PD 1201, PD 2501, DPT-1200, DPT-1200R, DPT- 2500, DPT-2500R and PD 12003		
	Preliminary instructions.....	6	4
	Equipment setup.....	7	4
	Torque	8	5
	Final procedure	9	8

*This bulletin supersedes TB 9-5120-212-35, dated 16 July 2003, including all changes.

			Paragraph	Page
SECTION	IV.	CALIBRATION PROCESS FOR POWER-DYNE, MODELS PD1220 AND PD1220B		
		Preliminary instructions	10	9
		Equipment setup.....	11	9
		Torque.....	12	10
		Final procedure	13	13
SECTION	V.	CALIBRATION PROCESS FOR ADVANCED TORQUE, MODEL CTW 1200-T55		
		Preliminary instructions	14	13
		Equipment setup.....	15	14
		Torque.....	16	15
		Final procedure	17	16

**SECTION I
IDENTIFICATION AND DESCRIPTION**

1. Test Instrument Identification. This procedure provides instructions for the calibration of Torque Wrenches, Power-Dyne, Models PD 1220, PD 1220B, PD 1201, and PD 501; Consolidated Devices, Models DPT-1200, DPT-1200R, DPT-2500, and DPT-2500R; Torque Applicator, Powerdyne, Model PD12003; and Advanced Torque, Model CTW 1200-T55. The manufacturers' manuals were used as the prime data sources in compiling these instructions. The equipment being calibrated will be referred to as the TI (test instrument) throughout this bulletin.

a. Model Variations. Variations among models are explained in text.

b. Time and Technique. The time required for this calibration is approximately 2 hours, using the physical technique.

2. Forms, Records, and Reports

a. Forms, records, and reports required for calibration personnel at all levels are prescribed by TB 750-25.

b. Adjustments to be reported are designated (R) at the end of the sentence in which they appear. When adjustments are in tables, the (R) follows the designated adjustment. Report only those adjustments made and designated with (R).

3. Calibration Description. TI parameters and performance specifications which pertain to this calibration are listed in table 1.

Table 1. Calibration Description

Test instrument parameters	Performance specifications
Torque: Power-Dyne, Model PD1201	Range: 0 to 1200 ft-lbs Accuracy: ±2% FS
Power-Dyne, Model PD2501	Range: 0 to 2500 ft-lbs Accuracy: ±2% FS
Power-Dyne, Model PD12003	Range: 0 to 12,000 ft-lbs ¹ Accuracy: ±3% of reading from 4000 to 7000 ft-lbs ±6% of reading throughout remainder of range
Power-Dyne, Model PD1220	Range: 250 to 1200 ft-lbs Accuracy: ±3% of reading
Power-Dyne, Model PD1220B	Range: 250 to 1200 ft-lbs Accuracy: ±1% FS from 250 to 1200 ft-lbs
Consolidated Devices: Models DPT-1200 and DPT-1200R	Range: 0 to 1200 ft-lbs Accuracy: ±2% of reading from 250 to 1200 ft-lbs
Models DPT-2500 and DPT-2500R	Range: 0 to 2500 ft-lbs Accuracy: ±2% of reading from 500 to 2500 ft-lbs
Advanced Torque: Model CTW 1200-T55	Range: 0 to 1250 ft-lbs Accuracy: ±1% FS from 250 to 1250 ft-lbs

¹Checked at 5500 and 6000 ft-lbs only.

SECTION II EQUIPMENT REQUIREMENTS

4. Equipment Required. Table 2 identifies the specific equipment to be used in this calibration procedure. This equipment is issued with Secondary Transfer Calibration Standards Set AN/GSM-286, AN/GSM-287 or AN/GSM-705. Alternate items may be used by the calibrating activity. The items selected must be verified to perform satisfactorily prior to use and must bear evidence of current calibration. The equipment must meet or exceed the minimum use specifications listed in table 2. The accuracies listed in table 2 provide a four-to-one ratio between the standard and TI. Where the four-to-one ratio cannot be met, the actual accuracy of the equipment selected is shown in parenthesis.

5. Accessories Required. The accessories listed in table 3 are issued as indicated in paragraph 4 above and are used in this calibration procedure. When necessary, these items may be substituted by equivalent items, unless specifically prohibited.

Table 2. Minimum Specifications of Equipment Required

Common name	Minimum use specifications	Manufacturer and model (part number)
FORCE/TORQUE INDICATOR	Range: ±0.1-3.06 mV/V Accuracy: ±0.03% indication	HBM, Model MGCPlus (13589298)
TORQUE CELL NO. 1	Range: 0 to 2500 ft-lbs Accuracy: ±0.5% of applied torque	Lebow, Model 2351-102 Type II, Class 1 (MIS-26485)

Table 2. Minimum Specifications of Equipment Required - Continued

Common name	Minimum use specifications	Manufacturer and model (part number)
TORQUE CELL NO. 2 ¹	Range: 0 to 12,000 ft-lbs Accuracy: ±0.5% of applied torque	Lebow, Model 2351-103 Type II, Class 2 (MIS-26485)

¹Part of High Capacity Torque System, 7916833.

Table 3. Accessories Required

Common name	Description (part number)
ADAPTER PLATE ¹	(ATPCA 1250)
DRIVE BAR ¹	CALIBRATION DRIVE BAR (CB 1200-1)
PULL HANDLE ¹	PULL HANDLE WITH ½ INCH SQUARE DRIVE
SILICONE RUBBER SEALER	8040-00-877-9872
TORQUE FIXTURE	(13335421)
TORQUE WRENCH	DIAL TYPE, 0-175 FTLB

¹For CTW 1200-T55 only.

**SECTION III
CALIBRATION PROCESS FOR
MODELS PD1201, PD2501, DPT-1200, DPT-1200R, DPT-2500, DPT-2500R AND
PD12003**

6. Preliminary Instructions

a. The instructions outlined in paragraphs 6 and 7 are preparatory to the calibration process. Personnel should become familiar with the entire bulletin before beginning the calibration.

b. Items of equipment used in this procedure are referenced within the text by common name as listed in table 2.

c. Unless otherwise specified, verify the result of each test and, whenever the test requirement is not met, take corrective action before continuing with the calibration. Adjustments required to calibrate the TI are included in this procedure. Additional maintenance information is contained in the manufacturer’s manual for this TI.

d. Unless otherwise specified, all controls and control settings refer to the TI.

7. Equipment Setup

a. Verify that TI is clean and free from defects that would impair its operation.





b. Ensure that the equipment has been allowed to stabilize at the ambient temperature.

c. Position torque plate (mounting plate for PD1201 and PD2501) on a stable and rigid work surface and secure with bolts or clamps.

d. Assemble TI and torque cell no. 1 (torque cell no. 2 for PD12003) on torque plate (mounting plate for PD1201 and PD2501) using appropriate drive bar and socket wrench

adapter. Ensure that locating pins and drive bar are engaged in their respective mounting holes. Install TI crank handle in socket as necessary.

e. Connect torque cell to force/torque indicator using cable supplied with force/torque indicator. Connect force/torque indicator to appropriate power source. Turn power switch to **ON** and allow the units to warm-up for 30 minutes. Select channel **3** using the **CHANNEL +** and **-** keys.

f. Press the **F4** key on the force/torque indicator until you see the   soft keys. Press the   soft keys as necessary to select the torque cell for the TI range and ccw torque. Ensure the serial number matches the torque cell being used.

NOTE

Turning the TI crank cw will cause ccw torque on the torque cell.

g. Press the **F4** key on the force/torque indicator until you see the **UNIT** soft key. Press the **UNIT** soft key as necessary to select **ftlb**.

h. Press the **SIGNAL ▲▼** to select the **GROSS** mode of operation. Press the **F4** key on the TI indicator until you see the **Acal** soft key. Press the **Acal** soft key as necessary to activate the **Acal** enunciator.

i. Set TI indicator to **0** with no torque applied.

NOTE

For DPT series set TI **ON/OFF** power switch to **ON**. If digital display does not indicate **000**, adjust **ZERO ADJUST** knob for an indication of **000**. Set ratchet for cw torque (Models DPT-1200R or DPT-2500R). Ensure that ratchet reversing ring is turned in the proper direction for cw torque.

8. Torque

a. Performance Check

NOTE

To prevent overshoot of desired torque, stop applying pressure approximately 30 ft-lbs before desired torque. Release crank momentarily and allow display to catch up. Continue cranking at slower speed and shorter increments.

NOTE

To reverse ratchet mechanism, crank handle from load (if any) to no load. Continue cranking while rotating the reversing ring until the ring freely snaps into proper position.

(1) Exercise TI as follows:

(a) Turn crank handle cw to obtain an approximate full-scale indication on TI indicator. The force/torque indicator will indicate ccw reaction torque.

(b) After 30 seconds, turn crank handle ccw to obtain a **0 (000 for DPT series)** indication on TI indicator.

(c) Repeat (a) and (b) above two times.

(d) Check TI for a **0 (000 for DPT series)** indication on TI indicator. Reset if necessary.

(2) Press the **F4** key on the force/torque indicator until you see **→0←** as soft key. Press the **→0←** soft key to zero force/torque indicator.

(3) Operate TI cw to obtain indications listed in table 4. If force/torque indicator indications are not within limits specified, perform **b** (1) through (10) below (**b** (11) through (13) for DPT series) (for PD12003 see note below). Turn TI crank handle ccw to remove torque.

NOTE

For PD12003, if indications are not in tolerance, prepare a test report (correction chart) showing actual values for nominal TI indications of 5500 and 6000 ft-lbs. Calibration points must be approached operating crank handle between the 2 o'clock and 4 o'clock positions.

NOTE

For PD 12003, if indications are not in tolerance, prepare a test report (correction chart) showing actual values for nominal TI indications of 5500 and 6000 ft-lbs.

NOTE

The calibration points must be approached in the direction of increasing torque. If calibration point is passed, reduce torque and approach calibration point again.

NOTE

On some models, it is necessary to lift pin on indexer ratchet drive on top of TI to change cw and ccw directions.

Table 4. Calibration Accuracy

Test instrument indications (ft-lbs)	Torque cell indications (ft-lbs)	
	Min	Max
Model PD1201 (and Models DPT-1200 and DPT-1200R)		
(250)	(245)	(255)
300 (400)	276 (392)	324 (408)
500 (600)	476 (588)	524 (612)
750 (800)	726 (784)	774 (816)
1000 (1000)	976 (980)	1024 (1020)
1200 (1200)	1176 (1176)	1224 (1224)

Table 4. Calibration Accuracy - Continued

Test instrument indications (ft-lbs)	Torque cell indications (ft-lbs)	
	Min	Max
Model PD2501 (and Models DPT-2500 and DPT-2500R)		
1500	1450 (1470)	1550 (1530)
2000	1950 (1960)	2050 (2040)
2500	2450 (2450)	2550 (2550)
Model PD 12003		
5500	5335	5665
6000	5820	6180

NOTE

Perform (4) below for ccw calibration only when specifically requested by user.

- (4) Perform paragraph 7 above and select the torque cell for the TI range and cw torque.
- (5) Repeat a (1) through (3) above, except turn crank handle ccw.
- (6) Turn TI crank handle cw to obtain a **0** indication.

b. Adjustments**NOTE**

Reaction arm must be free to move under retaining screws (fig. 1).

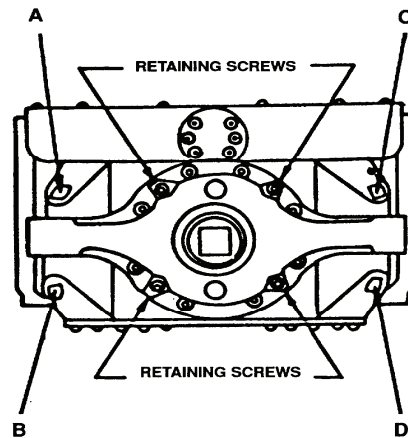

Figure 1. Torque wrench - adjustment locations.

- (1) If TI indication error is the same in both cw and ccw directions, adjust pointer of TI dial indicator.
- (2) If TI indication error is not the same in both directions, perform (3) through (10) below.
- (3) Remove sealant from the four adjustment screws A, B, C, and D (fig. 1) on the back of TI.

(4) Using appropriate size Allen wrench, back off screws A and B (fig. 1) at least three turns.

(5) Adjust screw C (fig. 1) until a pressure reading is shown on indicator, then back off screw until indication returns to 0.

(6) Check spacing between the reaction arm on sensing unit housing and reaction ears. If reaction arm is not centered between ears, adjust screws C and D (fig. 1) until sensor is centered.

(7) Turn screw A (fig. 1) inward until a pressure reading is shown on indicator and then back off to 0 plus one-quarter additional turn.

(8) Turn screw B (fig. 1) inward until a pressure reading is shown on indicator and back off to 0.

(9) Repeat **a** above and adjust screws B and C (fig. 1) slightly to bring TI indications within tolerance (R).

(10) Reseal retaining screws with silicone rubber sealer. Repeat table 4.

(11) Operate crank cw to obtain an indication of 800 ft-lbs (1200 ft-lbs for models DPT-2500 and DPT-2500R) on force/torque indicator.

(12) Adjust SPAN screw (fig. 2 and fig. 3) for an indication of 800 ft-lbs (1200 ft-lbs for models DPT-2500 and DPT-2500R) on digital display (R).

NOTE

It should not be necessary to adjust internal ZERO (fig. 2 and fig. 3) unless circuit board is repaired.

(13) Repeat (11) and (12) above two times and adjust, if necessary.

(14) Repeat table 4.

9. Final Procedure

a. Deenergize and disconnect all equipment.

b. Annotate and affix DA label/form in accordance with TB 750-25.

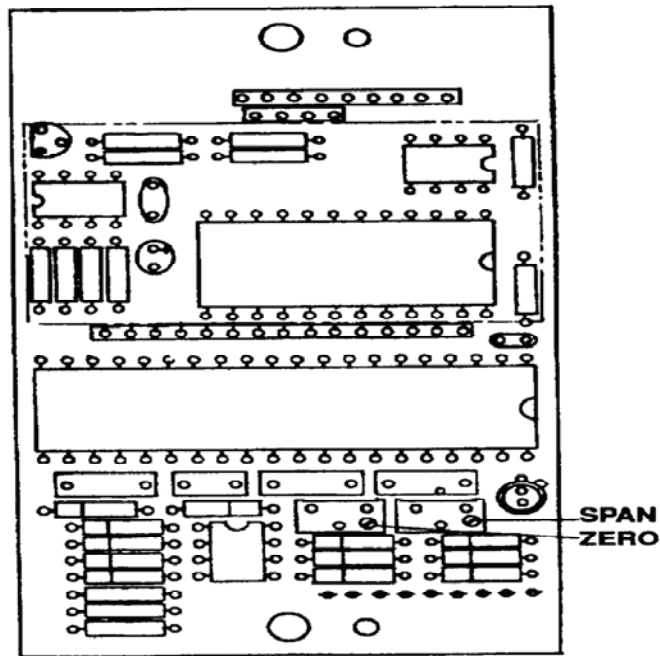

Figure 2. Consolidated Devices, Models DPT 1200 and DPT 1200R - adjustment locations.

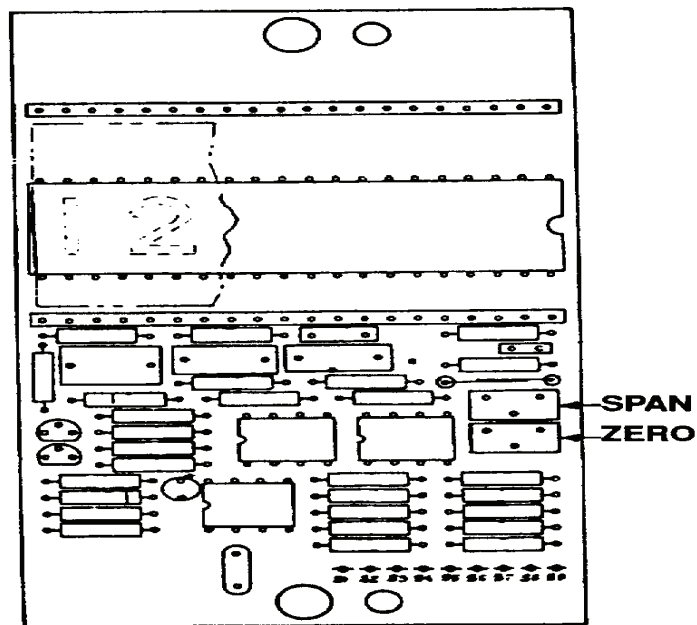

Figure 3. Consolidated devices, models DPT2500 and DPT-2500R - adjustment locations.

**SECTION IV
CALIBRATION PROCESS FOR
POWER-DYNE, MODELS PD1220 AND PD1220B**

10. Preliminary Instructions

a. The instructions outlined in paragraphs **10** and **11** are preparatory to the calibration process. Personnel should become familiar with the entire bulletin before beginning the calibration.

b. Items of equipment used in this procedure are referenced within the text by common name as listed in table 2.

c. Unless otherwise specified, verify the result of each test and, whenever the test requirement is not met, take corrective action before continuing with the calibration. Adjustments required to calibrate the TI are included in this procedure. Additional maintenance information is contained in the manufacturer's manual for this TI.

d. Unless otherwise specified, all controls and control settings refer to the TI.

11. Equipment Setup

a. Verify that TI is clean and free from defects that would impair its operation.

b. Ensure that equipment has been allowed to stabilize at the ambient temperature.

c. Position torque fixture on a stable and rigid work surface and secure with bolts or clamps.





d. Place torque cell no. 1 inside fixture with dowel pins engaging holes in bottom of fixture.

e. Place plate (furnished with torque fixture) on top of torque cell.

f. Insert drive bar into square opening in plate.

g. Place TI on fixture, engaging drive bar and dowel pins.

h. Connect torque cell to force/torque indicator using cable supplied with force/torque indicator. Connect force/torque indicator to appropriate power source. Turn power switch to **ON** and allow the units to warm-up for 30 minutes. Select channel **3** using the **CHANNEL +** and **-** keys.

i. Press the **F4** key on the force/torque indicator until you see the   soft keys. Press the   soft keys as necessary to select the torque cell for the TI range and direction being calibrated. Insure the serial number matches the torque cell being used.

j. Press the **F4** key on the force/torque indicator until you see the **UNIT** soft key. Press the **UNIT** soft key as necessary to select **ftlb**.

k. Press the **SIGNAL ▲▼** to select the **GROSS** mode of operation. Press the **F4** key on the TI indicator until you see the **Acal** soft key. Press the **Acal** soft key as necessary to activate the **Acal** enunciator.

12. Torque

a. Performance Check

WARNING

Friction brake must be adjusted to hold 1200 ft-lbs applied torque when pressure is released from T-handle.

(1) Check friction brake by carefully applying torque in small increments and ensuring that friction brake holds up to 1200 ft-lbs. If friction brake does not hold, tighten FRICTION ADJUSTMENT SCREW (fig. 4) to increase friction. Do not over-tighten because the friction brake must be overcome to back off torque that has been applied. Maximum torque needed to overcome brake should not exceed 75 ft-lbs.

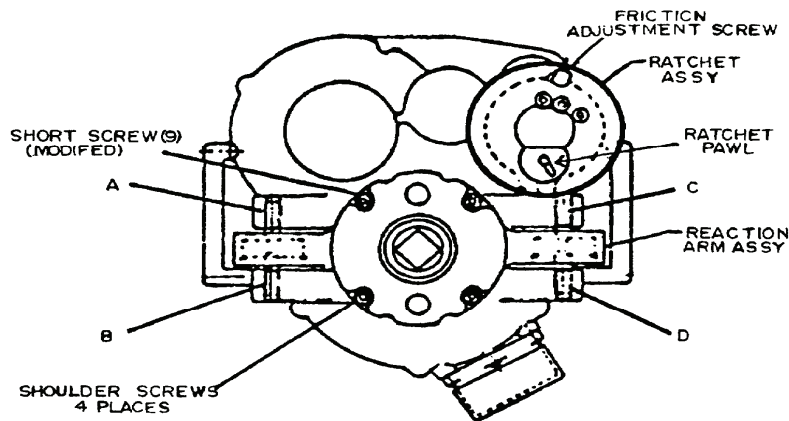

Figure 4. Torque wrench - adjustment locations.

NOTE

Two ratchets are used on this TI, one on the torque wrench and one on the T-handle. Operation of the T-handle ratchet is obvious. The torque wrench ratchet operates in conjunction with the friction brake. The RATCHET PAWL (fig. 4) is labeled nut-on for cw torque and nut-off for ccw torque.

CAUTION

Do not attempt to reverse the RATCHET PAWL (fig. 4) with torque applied. When torque is applied cw with RATCHET PAWL (fig. 4) in nut-on position, the T-handle must be turned ccw against resistance of the friction brake to release the applied torque.

(2) Exercise TI and torque cell scale three times in cw direction.

(3) Press the **F4** key on the force/torque indicator until you see →**0**← as soft key. Press the →**0**← soft key to zero force/torque indicator.









- (4) Check cw and ccw balance of TI as follows:
 - (a) Set RATCHET PAWL (fig. 4) to nut-on position.
 - (b) Turn T-handle cw to obtain a 500 ft-lb indication on TI indicator. Record indication of Force/torque indicator.
 - (c) Turn T-handle ccw to release applied torque.
 - (d) Press the **F4** key on the force/torque indicator until you see the   soft keys. Press the   soft keys as necessary to select the torque cell for the TI range and direction being calibrated. Insure the serial number matches the torque cell being used.
 - (e) Press the **F4** key on the force/torque indicator until you see the **UNIT** soft key. Press the **UNIT** soft key as necessary to select **ftlb**.
 - (f) Press the **SIGNAL ▲▼** to select the **GROSS** mode of operation. Press the **F4** key on the TI indicator until you see the **Acal** soft key. Press the **Acal** soft key as necessary to activate the **Acal** enunciator.
 - (g) Exercise TI and torque cell scale three times in ccw direction.
 - (h) Press the **F4** key on the force/torque indicator until you see **→0←** as soft key. Press the **→0←** soft key to zero force/torque indicator.
 - (i) Turn T-handle ccw to obtain a 500 ft-lb indication on TI indicator. Record indication of force/torque indicator. If indication is not within 5 ft-lbs of indication recorded in (b) above, perform **b** (1) through (3) below.
- (5) Turn T-handle cw to release applied torque.
- (6) Press the **F4** key on the force/torque indicator until you see the   soft keys. Press the   soft keys as necessary to select the torque cell for the TI range and direction being calibrated. Insure the serial number matches the torque cell being used.
- (7) Press the **F4** key on the force/torque indicator until you see the **UNIT** soft key. Press the **UNIT** soft key as necessary to select **ftlb**.
- (8) Press the **SIGNAL ▲▼** to select the **GROSS** mode of operation. Press the **F4** key on the TI indicator until you see the **Acal** soft key. Press the **Acal** soft key as necessary to activate the **Acal** enunciator.
- (9) Exercise TI and torque cell scale three times in cw direction.
- (10) Press the **F4** key on the force/torque indicator until you see **→0←** as soft key. Press the **→0←** soft key to zero force/torque indicator.
- (11) Set TI for cw operation.
- (12) Turn T-handle cw to obtain a 500 ft-lb indication on TI indicator. If force/torque indicator does not indicate between 485 and 515 ft-lbs (490 and 510 ft-lbs for Powerdyne, Model PD1220B), perform **b** (4) through (10) below.
- (13) Operate TI cw to obtain indications listed in table 5. If force/torque indicator indications are not within limits specified, repeat (4) through (12) above.

Table 5. Calibration Accuracy - Power-Dyne,
Models PD1220 (and PD1220B)

Test instrument Indications (ft-lbs)	Torque cell indications(ft-lbs)	
	Min	Max
250	242.5 (238)	257.5 (262)
300	291 (288)	309 (312)
750	727 (738)	773 (762)
1000	970 (988)	1030 (1012)
1175	1139 (1163)	1210 (1187)

(14) Turn T-handle ccw to release applied torque.

b. Adjustments

(1) Remove sealant from adjustment screws A and B (fig. 4). Screws C and D (fig .4) should not need adjustment unless TI is disassembled for repair or overhaul.

(2) Adjust screws A and B (fig. 4) slightly by backing one out and advancing the other one-quarter turn at a time.

(3) Repeat (2) above and continue adjustment in small increments until indications are within tolerance. When correctly adjusted, screws A, B, C, and D (fig. 4) should be just touching bellows assemblies (R).

(4) Remove rubber indicator protective cover.

(5) Remove lens retaining ring and lens from TI indicator.

(6) Turn T-handle to obtain a 500 ft-lb indication on force/torque indicator. Slip dial face to align pointer with 500 ft-lb graduation on dial face (R).

(7) Turn T-handle to relieve all applied torque from TI. Indicator must indicate within green band at 0.

(8) Install lens, retaining ring, and protective cover.

(9) Repeat **a** (3) through (5) above. If TI indications are not within tolerance, repeat **b** (2) through (8) above.

(10) Reseal adjustment screws with silicon rubber sealer.

13. Final Procedure

a. Deenergize and disconnect all equipment.

b. Annotate and affix DA label/form in accordance with TB 750-25.

**SECTION V
CALIBRATION PROCESS FOR
ADVANCED TORQUE, MODEL CTW 1200-T55**

14. Preliminary Instructions

- a. The instructions outlined in paragraphs 14 and 15 are preparatory to the calibration process. Personnel should become familiar with the entire bulletin before beginning the calibration.
- b. Items of equipment used in this procedure are referenced within the text by common name as listed in table 2.
- c. Unless otherwise specified, verify the result of each test and, whenever the test requirement is not met, take corrective action before continuing with the calibration. Adjustments required to calibrate the TI are included in this procedure. Additional maintenance information is contained in the manufacturer's manual for this TI.
- d. Unless otherwise specified, all controls and control settings refer to the TI.





15. Equipment Setup

- a. Verify that TI is clean and free from defects that would impair its operation.
- b. Ensure that equipment has been allowed to stabilize at the ambient temperature.
- c. Position torque fixture on a stable and rigid work surface and secure with bolts or clamps.
- d. Place torque cell no. 1 inside fixture with dowel pins engaging holes in bottom of fixture. Place plate (furnished with torque fixture) onto torque cell.

NOTE

Adapter plate must be used or damage to the TI may result.

- e. Install adapter plate on top of torque fixture inserting dowel pins into matching holes. Insert drive bar through central hole of adapter plate and top of torque fixture and into the square hole of the torque plate on top of the torque cell.
- f. Remove the stretch dial and pointer from the bottom of the TI by loosening two set screws on the side of the dial. Place the TI on the adapter plate engaging the drive bar and dowel pins. Install the pull handle in the TI socket (top).
- g. Turn on TI indicator using the **ON/OFF** pad. The display should read "WELCOME TO ADVANCED TORQUE LLC" followed by the range of the sensor that has been connected to the indicator.
- h. Press **Units** pad until it indicates ft/lbs.
- i. Select **Track** if the indicator is not already in Track mode.

- j. Zero the indicator by pressing the **ZERO** pad.
- k. Select AUTO mode by pressing the **PEAK/TRACK** pad.
- l. Connect torque cell to force/torque indicator using cable supplied with force/torque indicator. Connect force/torque indicator to appropriate power source. Turn power switch to **ON** and allow the units to warm-up for 30 minutes. Select channel **3** using the **CHANNEL +** and **-** keys.
- m. Press the **F4** key on the force/torque indicator until you see the   soft keys. Press the   soft keys as necessary to select the torque cell for the TI range and direction being calibrated. Insure the serial number matches the torque cell being used.
- n. Press the **F4** key on the force/torque indicator until you see the **UNIT** soft key. Press the **UNIT** soft key as necessary to select **ftlb**.
- o. Press the **SIGNAL ▲▼** to select the **GROSS** mode of operation. Press the **F4** key on the TI indicator until you see the **Acal** soft key. Press the **Acal** soft key as necessary to activate the **Acal** enunciator.

16. Torque

a. Performance Check

WARNING

The TI does not have a friction brake. Use caution when releasing the force applied to the TI. The force applied must be released carefully in both CW and CCW directions.

(1) Exercise TI as follows:

(a) Set anti-wind-up knob on TI to **CW**. Turn pull handle cw to obtain an approximate full-scale indication on TI indicator.

NOTE

In order to set the anti-wind-up knob from **CW** to **CCW** a small amount of cw force will need to be applied.

(b) Set anti-wind-up knob on TI to **CCW**. Slowly release pull handle ccw to obtain a **0** indication on TI indicator.

(c) Repeat (a) and (b) above two times.

WARNING

Do not apply torque while zeroing.

(d) Check TI for a **0** indication on TI indicator, press **ZERO** pad if necessary.

(2) Press the **F4** key on the force/torque indicator until you see **→0←** as soft key. Press the **→0←** soft key to zero force/torque indicator.

NOTE

The calibration points must be approached in the direction of increasing torque. If calibration point is passed, reduce torque and approach calibration point again.

NOTE

Readings should not be taken with wrench “resting” against a pawl. Readings must be made while applying steady force to the pull handle.

- (3) Set anti-wind-up knob on TI to **CW**. Operate TI cw to obtain indications listed in table 6. If force/torque indicator indications are not within limits specified, perform **b** below. Set anti-wind-up knob on TI to **CCW**. Slowly release pull handle ccw to remove torque.

Table 6. Calibration Accuracy

Test instrument Indications (ft-lbs)	Torque cell indications(ft-lbs)	
	Min	Max
250	238	262
300	288	312
750	738	762
1000	988	1012
1250	1238	1262

b. Adjustments

- (1) Set the force/torque indicator to measure ccw torque.
- (2) Exercise TI as follows:

(a) Set anti-wind-up knob on TI to **CCW**. Turn pull handle ccw to obtain an approximate full-scale indication on TI indicator.

NOTE

In order to set the anti-wind-up knob from **CCW** to **CW** a small amount of ccw force will need to be applied.

(b) Set anti-wind-up knob on TI to **CW**. Slowly release pull handle cw to obtain a **0** indication on TI indicator.

(c) Repeat (a) and (b) above two times.

- (3) Ensure no torque is currently applied to TI.
- (4) Press and hold the **PRINT** pad and press the **ZERO** pad.
- (5) The TI display will prompt “**ZERO LOAD CCW**”, press the **ZERO** pad again.

NOTE

When applying 1250 ft-lbs in both cw and ccw directions the load must be held steady for a few seconds after **RESET** pad is pressed so assistance will be needed.

(6) The TI display will prompt “**FULL LOAD CCW**”, turn pull handle ccw to obtain a reading of 1250 ft-lbs on the force/torque indicator.

(7) After the load has stabilized press the **RESET** pad.

(8) The TI display will prompt “**ZERO LOAD CW**”, remove load then press the **ZERO** pad.

(9) Set the force/torque indicator to measure cw torque.

(10) Exercise TI as follows:

(a) Set anti-wind-up knob on TI to **CW**. Turn pull handle cw to obtain a reading of 1250 ft-lbs on the force/torque indicator.

NOTE

In order to set the anti-wind-up knob from **CW** to **CCW** a small amount of cw force will need to be applied.

(b) Set anti-wind-up knob on TI to **CCW**. Slowly release pull handle ccw to obtain a **0** ft-lbs reading on the force/torque indicator.

(c) Repeat (a) and (b) above two times.

(11) The TI display will prompt “ **FULL LOAD CW**”, turn pull handle cw to obtain a reading of 1250 ft-lbs on the force/torque indicator.

(12) After the load has stabilized press the **RESET** pad.

(13) The TI display will prompt” **IF YOU ARE SURE PRESS RESET**”, press the **RESET** pad to enter the calibration values. Remove load from TI.

(14) Repeat paragraph **16**.

17. Final Procedure

a. Deenergize and disconnect all equipment.

b. Reinstall the stretch plate and pointer (Model CTW 1200-T55 only). Tighten set screws to 4-6 ftlbs.

c. Annotate and affix DA label/form in accordance with TB 750-25.

By Order of the Secretary of the Army:

Official:



JOYCE E. MORROW

*Administrative Assistant to the
Secretary of the Army*

0630404

GEORGE W. CASEY, JR.
*General, United States Army
Chief of Staff*

Distribution:

To be distributed in accordance with the initial distribution number (IDN) 343740, requirements for calibration procedure TB 9-5120-212-24.

INSTRUCTIONS FOR SUBMITTING AN ELECTRONIC 2028

The following format must be used if submitting an electronic 2028. The subject line must be exactly the same and all fields must be included; however, only the following fields are mandatory: 1, 3, 4, 5, 6, 7, 8, 9, 10, 13, 15, 16, 17, and 27.

From: "Whomever" whomever@redstone.army.mil
To: <2028@redstone.army.mil

Subject: DA Form 2028

1. **From:** Joe Smith
2. **Unit:** home
3. **Address:** 4300 Park
4. **City:** Hometown
5. **St:** MO
6. **Zip:** 77777
7. **Date Sent:** 19-OCT -93
8. **Pub no:** 55-2840-229-23
9. **Pub Title:** TM
10. **Publication Date:** 04-JUL-85
11. **Change Number:** 7
12. **Submitter Rank:** MSG
13. **Submitter FName:** Joe
14. **Submitter MName:** T
15. **Submitter LName:** Smith
16. **Submitter Phone:** 123-123-1234
17. **Problem:** 1
18. **Page:** 2
19. **Paragraph:** 3
20. **Line:** 4
21. **NSN:** 5
22. **Reference:** 6
23. **Figure:** 7
24. **Table:** 8
25. **Item:** 9
26. **Total:** 123
27. **Text**

This is the text for the problem below line 27.

